

Perforations shown actual size

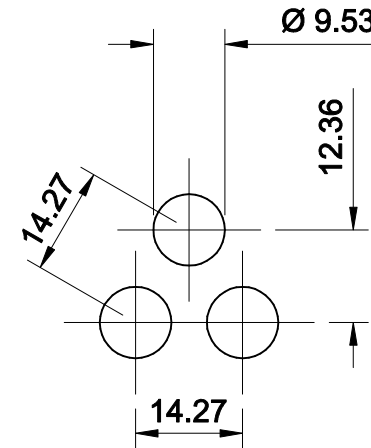

Detail



Perftech Pty. Ltd.
 10 Macquarie Drive, Thomastown, Vic. 3074
 Tel. (03) 9465 8000
 Fax. (03) 9465 5500
 email. sales@perftech.com.au

PART No. P9514

PATTERN Round staggered

HOLE SIZE Ø 9.53 mm

PITCH 14.27 mm

OPEN AREA 40%