

Perforations shown actual size

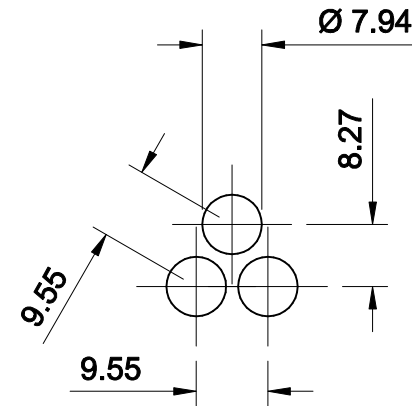

Detail



Perftech Pty. Ltd.
 10 Macquarie Drive, Thomastown, Vic. 3074
 Tel. (03) 9465 8000
 Fax. (03) 9465 5500
 email. sales@perftech.com.au

PART No.	P7995
PATTERN	Round staggered
HOLE SIZE	Ø 7.94 mm
PITCH	9.55 mm
OPEN AREA	62%